

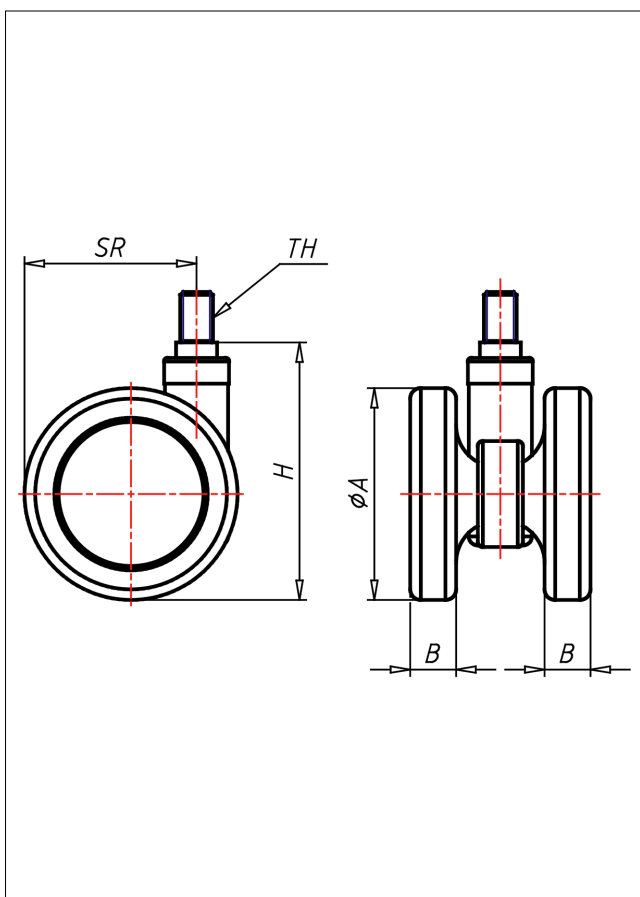

550 M10/M12 PU

Lenkrolle



Technische Details

ORDERNO (Artikel-nummer)	550 M10 75 PU
WDAB (Rad- ϕ A x Breite B / mm)	75x18+18
LC (Tragkraft / kg)	70
H (Bauhöhe H / mm)	90
TH (Gewinde / mm)	M10x15
SR (Schwenkradius / mm)	60.5
WB (Radlager)	Polyamid-Gleitlager